



### Model Number:

**ST-0721206-2835-S**



**IP20**



SunTech Lite is committed to provide high quality LED lighting product and superior service for market.

元硕达科技致力于提供高品质的LED产品，提供高品质的市场服务。

1. The LED are packaged with pure gold wires and large-size chips.  
灯珠采用纯金线和大尺寸芯片封装。
2. Only one Bin LED is used for each order, and keep the same Bin LED in subsequent orders to ensure the consistency of the product.  
每一个订单只使用一个BIN的灯珠，并且在后期订单也使用相同BIN，保证产品的一致。
3. The production process adopts high-temperature, lead-free SMT technology, the solder joints are smooth and full.  
生产过程采用高温无铅SMT工艺，焊点圆滑饱满。
4. Use double-layer PCB to ensure stable electrical performance.  
采用双面线路板，保证稳定的电气性能。
5. Use original authentic 3M tape, strong and long-lasting adhesion.  
原装正品3M胶带，粘合力持久强劲。
6. A variety of installation accessories are optional, flexible and convenient to use.  
多种安装配件可选，使用灵活方便。
7. Different IP grade are available: IP20, IP65, IP66, IP68.  
防水等级可选: IP20, IP65, IP66, IP68。
8. High light transmittance, environment friendly silicone material is used for waterproof product, colorless, odorless and anti-yellowing.  
防水材料用高透环保硅胶材料：无色，无味，抗黄化。

## Product description/产品描述

1. Dimensions: 6mm, 5m/roll  
产品尺寸：6mm，5米/卷
2. Power: 7.2W/m  
产品功率：7.2W/米
3. LED type: SMD2835, high brightness LED  
灯珠型号：SMD2835，高亮LED
4. LED quantity: 72LEDs/m, 360LEDs/roll  
灯珠数量：72灯/米，360灯/卷
5. LED color: white, red, green, blue, yellow etc.  
灯珠颜色：白光、红光、绿光、蓝光、黄光等
6. Cut length: 12V 3LEDs/41.66mm  
剪切长度：12V 3灯/41.66mm
7. PCB material: double layer FPC  
PCB材质：双面FPC
8. Life time: 50000hours  
产品寿命：50000小时
9. IP grade: IP20  
防水等级：IP20

## Application/应用

- Interior design  
室内设计
- Architectural design  
建筑设计
- Advertisement project  
广告项目
- Outdoor illuminated signs  
户外照明标志
- Billboard decoration  
广告牌装饰
- Display design  
展示设计
- Underwater lighting project  
水下照明工程
- Car decoration  
汽车装饰
- City beautification  
城市美化

## Product picture/产品图片



## Application scenarios/应用场景



Counter lighting  
柜台照明

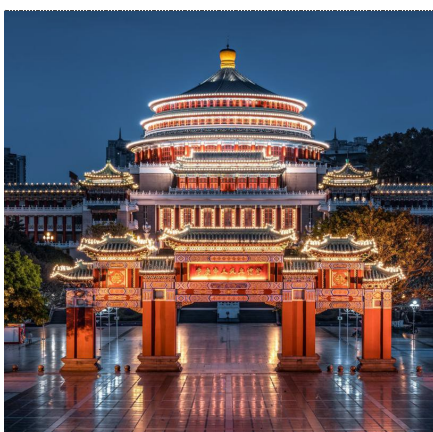

City beautification  
城市美化

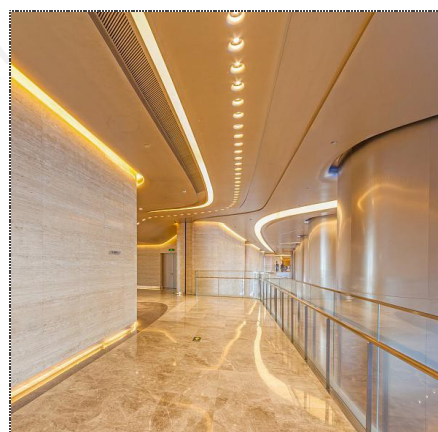

Interior design  
室内设计



Outdoor illuminated  
户外照明

## Technical parameters/技术参数

Optical parameters(white) 光学参数 (@白光)	Electrical performance parameters 电气性能参数	Other parameters 其它参数
Luminous/光通量: 590Lm/m	Voltage/额定电压: DC12V	Storage temperature/ 储存温度: -20~+60°C
CCT/色温: 1800-20000K	Current/额定电流: 0.6A/m	Working temperature/ 工作温度: -20~+60°C
CRI/显色指数: Ra>80	Power/额定功率: 7.2W/m	Life time/ 使用寿命: >50000 hours
Beam angle/发光角度: 120°		

## Dimensions/外型尺寸

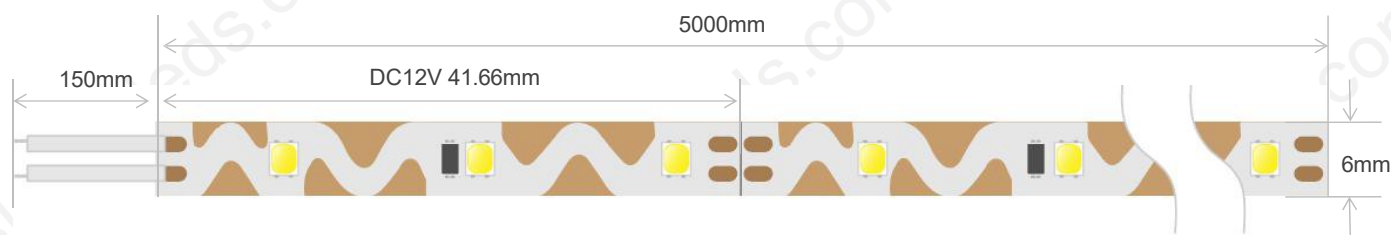

## Color standard/颜色标准



## Connection diagram/连接图

### 1. Connection method one/接线方式一

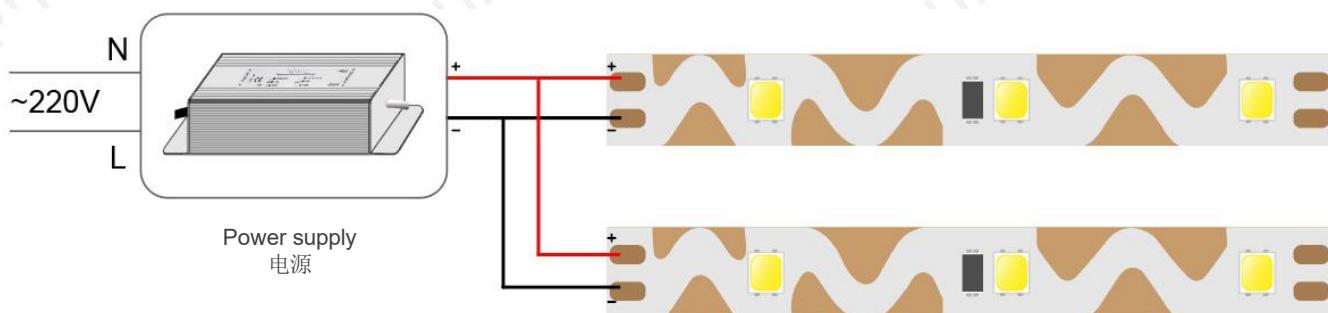

### 2. Connection method two/接线方式二

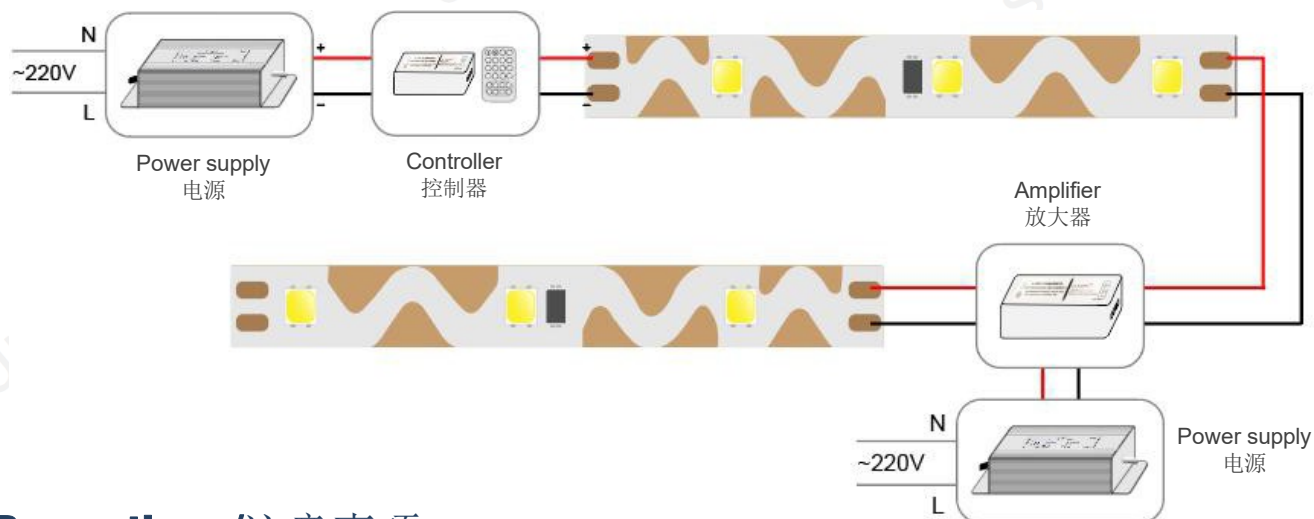

## Precautions /注意事项



- ▶ Please cut it according to the cutting line, do not cut it at other positions.
- ▶ 剪切时请按剪切线剪，不可在其它位置剪。

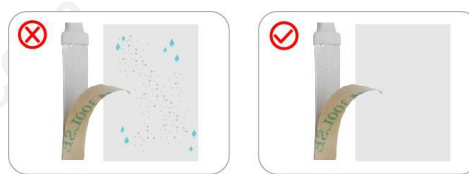

- ▶ Please make sure the wall is dry and free of dust before pasting.
- ▶ 粘贴前请确认墙面干燥无粉尘。



- ▶ Do not fold, twist or step on the led strips.
- ▶ 灯条禁止折、扭、踩。



- ▶ The LED strip wire ends cannot be shorted together.
- ▶ 灯条线头不可短接在一起。

## Accessories/配件



Power Supply/电源



Connector/连接器



Weldless connector/免焊接头



Controller /控制器

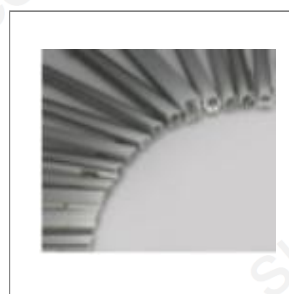

Aluminum profile/铝材

- Notes/备注 :**
- ▶ Please purchase the above accessories according to your demand.
  - ▶ 以上所有配件，请根据需求购买。

## Packing instruction/包装说明

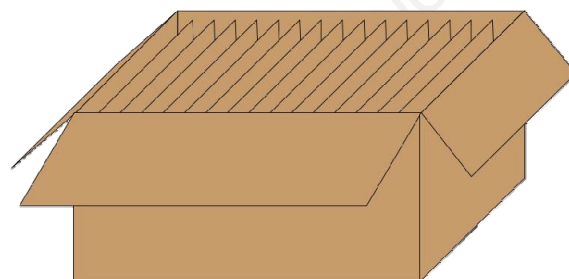

### Notes/备注

- ▶ The regular packing is 5m/roll, special length need to be customized.  
常规产品5米/卷，特殊长度需要定制。
- ▶ Do not place heavy products on the top of the cartons, do not step on it.  
包装箱上方不可放置重物，禁止踩踏。
- ▶ After receiving the package, if the outer box was damaged, please check the goods before signing for receipt.  
收到物品，如发现外箱破损，请先验货再签收。